

# OWNER'S MANUAL

## 6.5HP Mulcher/Chipper



# OWNER'S MANUAL

Assembly & Operating Instructions

## GARDEN MULCHER / CHIPPER

MODEL NO. BBT-MUL-6.5HPBS



6.5hp B&S Mulcher/Chipper



## To The Owner

Thank you for purchasing our Mulcher. It was carefully engineered to provide excellent performance when properly operated and maintained.

Please read this entire manual prior to operating the Mulcher. It instructs you how to safely and easily set up, operate and maintain your Mulcher. Please be sure that you and any other persons who will operate the Mulcher carefully follow the recommended safety practices at all times. Failure to do so could result in personal injury or property damage.

All information in this manual is relative to the most recent product information available at the time of printing. Review this manual frequently to familiarise yourself with the machine, its features and operation. Please be aware that this Owner's Manual may cover a range of product specifications for various models. Characteristics and features discussed and/or illustrated in this manual may not be applicable to all models. We reserve the right to change product specifications, designs and equipment without notice and without incurring obligation.

All the power testing information used to establish the power rating of the engine equipped on this Mulcher can be found in the engine manufacturer's manual or website. If you have any problems or questions concerning the machine, please contact our Customer Support Department.

Throughout this manual, all references to right and left side of the Mulcher are observed from the operating position. The engine manufacturer is responsible for all engine-related issues with regards to performance, power-rating, specifications, warranty and service. Please refer to the engine manufacturer's Owner's Manual packed separately with your Mulcher for more information.

## Customer Support

*Please do NOT return the Mulcher without first contacting the Customer Support Department at [bbt@bbta.com.au](mailto:bbt@bbta.com.au).*

If you have difficulty assembling this product or have any questions regarding the controls, operation, or maintenance of this Mulcher, please contact our Customer Support Department.

**SAVE THESE INSTRUCTIONS**

# TABLE OF CONTENTS

	Page(s)
To The Owner.....	2
Customer Support.....	2
<b>TABLE OF CONTENTS .....</b>	<b>3</b>
<b>IMPORTANT SAFETY INFORMATION.....</b>	<b>4-5</b>
Additional Information and Potential Changes.....	4
Key to Symbols.....	5
<b>SAFETY INFORMATION .....</b>	<b>6-7</b>
Before Operating the Unit for the First Time .....	6
Preparation .....	6
Safety Label Locations.....	7
Safety Information.....	7
Operator Responsibility.....	7
<b>ASSEMBLY.....</b>	<b>7</b>
<b>OPERATING GUIDELINES.....</b>	<b>8</b>
<b>OPERATING INSTRUCTIONS .....</b>	<b>9</b>
Add Petrol and Oil .....	9
Starting the Engine.....	9
Using the Chipper Shredder .....	9
<b>MAINTENANCE &amp; STORAGE .....</b>	<b>10-12</b>
Maintenance Schedule .....	10
Maintenance and Storage.....	10
If the Mulcher Discharge Chute Becomes Clogged.....	10
Removing and Sharpening the Blade .....	11
Changing or Tightening the Belt .....	11
Cleaning the Chipper/Shredder.....	12
Storing the Chipper/Shredder .....	12
<b>SPECIFICATIONS.....</b>	<b>12</b>
<b>TROUBLESHOOTING.....</b>	<b>13</b>
<b>WARRANTY &amp; SERVICE .....</b>	<b>14</b>
<b>EXPLODED DIAGRAM &amp; PARTS LIST.....</b>	<b>15</b>
Component Parts Diagram.....	15
<b>YOU MAY ALSO LIKE .....</b>	<b>16</b>



## IMPORTANT SAFETY INFORMATION



**WARNING:** Read and thoroughly understand all instructions in this manual and on the safety decals before assembling or operating this Mulcher. Failure to do so may cause serious injury or death. Do not allow anyone to operate this Mulcher who has not read this manual. As with all power equipment, a Mulcher can be dangerous if assembled or used improperly. Do not operate this Mulcher if you have any questions concerning its safe operation. To get answers to any questions, call our Customer Support Department.



This **SAFETY ALERT SYMBOL** identifies important safety messages in this manual. Failure to follow this important safety information may result in serious injury or death.



**DANGER!** This Mulcher was built to be operated according to the safe operation practices in this manual. As with any type of power equipment, carelessness or error on the part of the operator can result in serious injury. This Mulcher is capable of amputating hands and feet and throwing debris. Failure to observe the following safety instructions could result in serious injury or death.

The following signals, words and meanings are intended to explain the levels of risk associated with this product.



**DANGER** indicates a hazardous situation which, if not avoided, will result in serious injury or death.



**WARNING** indicates a hazardous situation which, if not avoided, could result in serious injury or death.



**CAUTION** indicates a hazardous situation which, if not avoided, could result in minor or moderate injury.

**NOTICE**

**NOTICE** is important information about the proper use of your Mulcher. Failure to follow this instruction could result in damage to your Mulcher or property.

### Additional Information and Potential Changes

We reserve the right to discontinue, change, and improve our products at any time without notice or obligation to the purchaser. The descriptions and sections contained in this manual were in effect at the time of printing. Equipment described within this manual may be optional. Some illustrations may not be applicable to your machine.











**WARNING!** Your Responsibility—Restrict the use of this power machine to persons who have read, understood and will follow the warnings and instructions in this manual and on the machine.

**SAVE THESE INSTRUCTIONS!**

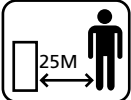

# IMPORTANT SAFETY INFORMATION

## Key to Symbols

Symbol	Description
	<b>READ THE OWNER'S MANUAL(S)</b> Read, understand and follow all instructions in the manual(s) before attempting to assemble and operate.
	<b>FACE PROTECTION</b> Always wear safety goggles or safety glasses with side shields or a face shield when operating this product as well as ear protection.
	<b>WEAR GLOVES</b> Always wear non-slip, heavy-duty protective gloves when operating this product.
	<b>WEAR SAFETY FOOTWEAR</b> Always wear non-slip steel-toed safety footwear when operating this product.
	<b>BEWARE OF ROTATING BLADES</b> This machine has a rotating cutting blade capable of amputating hands and feet and throwing objects. Keep hands and feet out of openings while machine is running. Failure to observe these safety instructions could result in serious injury or death.
	<b>BEWARE OF FLYING OBJECTS</b> Beware of thrown objects, which can ricochet causing serious injury to the eyes. Always wear eye & ear protection when operating.
	<b>CARBON MONOXIDE AND GAS</b> Exhaust contains poisonous carbon monoxide, a colourless and odourless gas. Breathing exhaust fumes can cause loss of consciousness and may lead to death.
	<b>BYSTANDERS</b> Keep bystanders, helpers, pets, and children at least 25m from the machine while it is in operation. Stop machine if anyone enters the area.
	<b>PETROL OIL</b> Petrol is extremely flammable and the vapours are explosive. Serious personal injury can occur when petrol is spilled on you or your clothing, which can ignite. In the event of a petrol spill, wash your skin and change clothes immediately.
	<b>NEVER</b> wear loose clothes or long jewellery and keep your long hair secured when operating machine. Never operate this machine in bare feet or sandals. Never use machine on a slope or hard smooth floor.
	<b>DO NOT</b> operate this machine unless the chute deflector has been installed properly.
	<b>DO NOT</b> attempt to deposit branches larger than the side chute into the opening. <b>DO NOT</b> deposit branches larger than 10mm into the top chute. <b>DO NOT</b> force the branches into this machine; allow the machine to automatically feed through.

# SAFETY INFORMATION

## Before Operating the Unit for the First Time

1. Read, understand, and follow all instructions on the machine and in the manual before attempting to assemble and operate. Keep this manual in a safe place for future and regular reference and for ordering replacement parts.
2. Make yourself familiar with all controls and their proper operation. Know how to stop the machine and disengage them quickly.
3. **NEVER** allow children under 18 years old to operate this machine. Individuals 18 years old and over should read and understand the operation instructions and safety rules in this manual prior to operation.
4. **NEVER** allow adults to operate this machine without proper instruction.
5. Keep bystanders, helpers, pets, and children at least 25 metres from the machine while it is in operation. Stop the machine if anyone enters the area.
6. **NEVER** run an engine indoors or in a poorly ventilated area. Engine exhaust contains carbon monoxide, an odourless and deadly gas.
7. **DO NOT** put hands or feet near rotating parts or in the feeding chambers and discharge opening. Contact with the rotating impeller can amputate fingers, hands, and feet.
8. **NEVER** attempt to unclog either the feed intake or discharge opening, remove or empty bag, or inspect and repair the machine while the engine is running. Shut the engine off and wait until all moving parts have come to a complete stop. Disconnect the spark plug wire and ground it against the engine.

## Preparation

1. Thoroughly inspect the area where the chipper/shredder is to be used. Remove all rocks & foreign objects which could be picked up or thrown and cause personal injury or damage to the machine.
2. Avoid discharging chipped material out of the discharge chute against a wall or on asphalt, concrete, or other hard surfaces as material being ejected could ricochet, causing injury to you or bystanders.
3. Always wear protective eye gear during operation or while performing an adjustment or repair.
4. Wear sturdy, rough-soled work shoes and close fitting pants and shirts. Loose fitting clothing or jewellery can be caught in movable parts. Wear leather work gloves when feeding material in the chipper chute.
5. Before starting the engine, check bolts and screws for proper tightness to be sure the machine is in safe working condition. Also, visually inspect the chipper shredder at frequent intervals for any damage.
6. Maintain or replace safety and instruction labels, as necessary.
7. To avoid personal injury or property damage use extreme care in handling fuel.
  - a. Use only an approved fuel container.
  - b. Extinguish all cigarettes, cigars, pipes, and other sources of ignition.
  - c. **NEVER** add fuel to machine indoors.
  - d. **NEVER** remove fuel cap or add fuel while the engine is hot or running.
  - e. Allow engine to cool for at least 2 minutes before refuelling.
  - f. **NEVER** over fill fuel tank. Leave at least 15mm of space below filler neck to provide space for fuel expansion.
  - g. Tighten fuel cap securely.
  - h. If fuel is spilled, wipe it off the engine and equipment. Move machine to another area and wait 5 minutes before starting the engine.
  - i. **NEVER** store machine or fuel container inside, near an open flame, spark, or pilot light (e.g. furnace, water heater, space heater, clothes dryer, etc.).
  - j. To reduce the fire hazard, keep machine free of grass, leaves, or other debris build- up. Clean up oil or fuel spills and remove any fuel soaked debris.
  - k. Allow machine to cool at least 5 minutes before storing.
8. **NEVER** attempt to make any adjustments while the engine (motor) is running (except where specifically recommended by the manufacturer).

# SAFETY INFORMATION

## Safety Label Locations

These labels warn you of potential hazards that can cause serious injury. Read them carefully.

## Safety Information

This product is designed to give safe and dependable service if operated according to instructions. Read and understand this owner's manual before operating your power equipment.

## Operator Responsibility

Know how to stop your power equipment quickly in case of emergency. Understand the use of all controls and connections. Be sure that anyone who operates this power equipment receives proper instruction.

**DO NOT** let children operate the power equipment.

# ASSEMBLY

### 1. Remove the chipper from its carton.

Cut strapping, remove corner supports including at base of unit, lift the carton to remove.

### 2. Remove all parts located inside mulching chute and around base of unit.

Ensure all parts are in the chipper carton.

- Engine and body (pre-assembled)
- Chipper Chute
- 2 x Wheels
- Front Support Leg
- Hardware Bag
- Handle Bars
- Axle

### 3. Attach the handles

Remove the nut and one washer from each bolt provided with the handles. Insert the handle bolts into the corresponding holes in the hopper. Secure the handles in place with the washer and nut on the inside of the hopper. Tighten the nuts using the 13mm spanner provided.

### 4. Attach the axle

Remove the bolts, washers, spring washers and nuts from inside the axle holes. Line up the holes in the axle with those in the mulcher base and secure with these nuts, bolts and washers. Tighten nuts using the 13mm spanner provided.

### 5. Attach the Wheels

Remove the lock nuts on the axle. When installing wheels, ensure that the tyre inflation valves are on the outside. Place wheels on axle and secure with lock nut

### 6. Attach the Front Support Leg

Remove the front support pin and tube. Open the bottom section of the discharge chute fully. Line up the holes in the front support leg with those in the bottom discharge chute. Re-insert the front support tube and pin with the bolts to secure the support leg. Tighten.

### 7. Attach the Side Chipper Chute

Line up the side chute with the studs in the side of the machine. Tighten nuts using 13mm spanner provided.



# OPERATING GUIDELINES

READ THESE OPERATING GUIDELINES BEFORE YOU PROCEED ANY FURTHER

1. **DO NOT** put hands and feet near rotating parts or in the feeding chambers and discharge opening. Contact with the rotating impeller can amputate fingers, hands and feet.
2. Before starting the machine, make sure the chipper chute, feed intake, and cutting chamber are empty and free of all debris.
3. Thoroughly inspect all material to be shredded and remove any metal, rocks, or other foreign objects which could cause personal injury or damage to the machine.
4. If it becomes necessary to push material through the shredder hopper, use a small diameter stick. Do not use your hands or feet.
5. If the impeller strikes a foreign object or if your machine should start making an unusual noise or vibration, immediately shut the engine off. Allow the impeller to come to a complete stop. Disconnect the spark plug wire, ground it against the engine and perform the following steps:
  - a. Inspect for damage.
  - b. Repair or replace any damaged parts.
  - c. Check for any loose parts and tighten to assure continued safe operation.
6. **DO NOT** allow an accumulation of processed material to build up in the discharge area. This can prevent proper discharge and result in kickback of material through the feed opening.
7. **DO NOT** attempt to shred or chip material larger than specified on the machine or in this manual. Personal injury or machine damage could result.
  - a. The hopper is for leaves only. **DO NOT use the hopper for vines or long branches as they may clog the rotating blades.**
  - b. The side chute is for longer and/or thicker pieces of yard waste.
8. **NEVER** attempt to unclog either the feed intake or discharge opening while the engine is running. Shut the engine off, wait until all moving parts have stopped, disconnect the spark plug wire and ground it against the engine before clearing debris.
9. **NEVER** operate without the hopper, chipper chute, or discharge chute properly attached to the machine.
10. **NEVER** empty or change discharge bag while the engine is running. Stop the engine when leaving the operating position.
11. Keep all guards, deflectors and safety devices in place and operating properly.
12. Keep your face and body back and to the side of the chipper chute while feeding material into the machine to avoid accidental kickback injuries.
13. **NEVER** operate this machine without good visibility or light.
14. **DO NOT** operate on a non-level surface.
15. **DO NOT** operate in a confined space.
16. **DO NOT** operate this machine while under the influence of alcohol or drugs.
17. **DO NOT** touch the muffler and engine as they become hot and can cause a burn.
18. **NEVER** pick up or carry machine while the engine is running.
19. **DO NOT** leave the machine running while unattended.
20. Keep children, bystanders, and pets 25m away.
21. Use only manufacturer approved accessories/attachments.

# OPERATING INSTRUCTIONS



This machine was built to be operated according to the rules for safe operation in this manual. As with any type of power equipment, carelessness or error on the part of the operator can result in serious injury.



Always wear hearing and eye protection while operating this machine or if you are within 25 metres of this machine.

**IMPORTANT:** This unit is shipped without petrol or oil in the engine. Be certain to fill the engine with petrol and oil as instructed before operating your machine.

## Add Petrol and Oil

**Step 1:** Add petrol (recommended 95 - 98 unleaded)

**Step 2:** Add approximately 600ml of SAE30 engine oil until the oil is about to overflow from the oil fill spout. A low oil sensor will prevent the engine from running unless the oil is COMPLETELY FULL. Ensure both oil fill plugs are secure after filling.

**NEVER** fill fuel tank indoors, with engine running or until the engine has been allowed to cool for at least 2 minutes after running.

## Starting the Engine

**Step 3:** Attach spark plug wire to spark plug. Make certain the metal cap on the end of the spark plug is fastened securely over the metal tip on the spark plug.

**Step 4:** Move choke lever on engine to CHOKE position. (A warm engine may not require choking).

**Step 5:** Turn the fuel valve to the ON position.

**Step 6:** **Electric Start:** Turn key to ON position, then to START.

**Pull-Start:** Turn Key to ON position. Grasp starter handle and pull rope out slowly until engine reaches start of compression cycle (rope will pull slightly harder at this point). Pull rope with a rapid, continuous, full arm stroke. Keep a firm grip on starter handle. Let the rope rewind slowly. Repeat the previous steps until engine fires.

Rapid retraction of the recoil starter cord can pull the starter cord back faster than you can let go. When starting the engine, pull the cord slowly until resistance is felt then pull rapidly to avoid kickback.

**Step 7:** When engine starts, move choke control gradually to the RUN position.

**NOTE:** A noise will be heard when finding the start of the compression cycle. This noise is caused by the flails and fingers, which are part of the shredding mechanism, and should be expected until the impeller reaches full speed.

**Step 8:** After engine is started, gradually release choke.

## Using the Chipper Shredder

Yard waste such as leaves and pine needles can be raked up and placed in the hopper for shredding.

**DO NOT PUT BRANCHES INTO THE HOPPER. BRANCHES SHOULD BE FED INTO THE SIDE CHIPPER CHUTE.**

When using the side chipper chute to chip branches, it is important to let the chipper feed the branches through automatically.

**DO NOT** attempt to force the branches through. If the branches do not automatically feed through, gently push the branch and then allow the chipper to automatically feed the branch through. Forcing branches into the side chute may wear the belt prematurely.

Once material is shredded by the hammers on the impeller assembly, it is discharged through the open discharge chute or into the chipper bag.

**DO NOT** attempt to shred or chip any material other than normal yard vegetation found (i.e., branches, leaves, twigs, etc.)

**IMPORTANT:** The hammer screen is located inside the housing in the discharge area. If the screen becomes clogged, remove and clean as instructed. For best performance, it is also important to keep the chipper blade sharp.

# MAINTENANCE AND STORAGE

## Maintenance Schedule

	Before each use	20hrs or every 3 months	50hrs or every 3 months	100hrs or every 6 months	300hrs or every 1 years
Engine Oil (Check)	X				
Engine Oil (Change)					X
Air Cleaner (Check)	X				
Air Cleaner Wash			X		
Fuel Filter Cap (Clean)				X	
Spark Plug (Clean)				X	
Spark Plug (Change)					X
Check Chipper Blade		X			
Fuel Tank and Filter (Clean)				X	



Always stop engine, disconnect spark plug and ground against engine before cleaning, lubricating or doing any kind of maintenance on your machine.

## Maintenance and Storage

1. **NEVER** tamper with safety devices. Check their proper operation regularly.
2. Check bolts and screws for proper tightness at frequent intervals to keep the machine in safe working condition. Also, visually inspect machine for any damage and repair, if needed.
3. Before cleaning, repairing or inspecting, stop the engine and make certain the impeller and all moving parts have stopped. Disconnect the spark plug wire and ground it against the engine to prevent unintended starting.
4. Maintain or replace safety and instruction labels as necessary.
5. Follow this manual for safe loading, unloading, transporting, and storage of this machine.
6. **NEVER** store the machine or fuel container inside where there is an open flame, spark or pilot light such as a water heater, furnace, clothes dryer, etc.
7. Always refer to the operator's manual for proper instructions on off-season storage.
8. If the fuel tank has to be drained, do this outdoors.
9. Observe proper disposal laws and regulations for petrol, oil, etc. to protect the environment.



Always stop engine, disconnect spark plug and ground against engine before cleaning, lubricating or doing any kind of maintenance on your machine.

## If the Mulcher Discharge Chute Becomes Clogged

- Stop the engine. Disconnect spark plug wire from spark plug and ground against the engine.
- Remove the mulcher screen. Reach in and clear the debris causing the blockage. Reinstall the mulcher screen.
- Connect the spark plug wire and restart.

# MAINTENANCE AND STORAGE

## Removing and Sharpening the Blade

- Disconnect the spark plug wire and ground against the engine.
- Remove the blade access hatch and rotate the blade to align with the access hatch.
- Remove the mulcher screen in the discharge chute by removing the pins that secure it at the top and bottom of the screen.
- Remove the blade using a 3/16" allen key on the outside of the blade and an adjustable wrench on the impeller assembly (through the discharge chute). Use a piece of pipe or wood to block the hammer blades, preventing them from inadvertently turning.
- Replace or sharpen the blade as desired.
- When sharpening the blade, protect hands by using gloves.

**NOTE:** Make certain the blade is reassembled with the sharp edge facing upward.

## Changing or Tightening the Belt

**NOTE:** The belt is designed to be the weakest link in the mechanical linkage between the engine and the blade. This improves the safety and durability of the chipper/shredder.

Occasionally, changing or tightening the belt is required.

### To change the belt:

- Stop the engine and make certain the blades have come to a complete stop. Disconnect the spark plug wire from spark plug and ground against the engine.
- Remove the belt guard.
- Loosen engine mount bolts and release belt tension.
- Pry the belt off the pulley using a screw driver shaft as a wedge as you rotate the pulley.
- Place a new belt on the pulleys in a similar fashion.

### To tighten the tension on the pulleys, follow the above steps plus:

- Scribe a mark on the base plate along the edge of the engine.
- Remove the belt from the pulleys.
- Remove the upper discharge chute and mulcher screen.
- Loosen the four bolts securing the engine.
- Slide the engine about 1/8" further back.
- Tighten the engine mounting bolts securely.
- Re-install the belt and verify the tension. If the belt is still too loose, move the engine back another 3mm by repeating the above steps.
- Reinstall guards, chutes, and screens.

# MAINTENANCE & STORAGE

## Cleaning the Chipper/Shredder

- Make sure engine is off.
- Wipe off machine with an oiled rag to prevent rust.
- If the fuel tank has to be drained, do so outdoors.
- Observe proper disposal laws and regulations for petrol, oil, etc., to protect the environment.

## Storing the Chipper/Shredder

- Clean the equipment thoroughly.
- Wipe equipment with an oiled rag to prevent rust.
- Refer to engine manual for correct engine storage instructions.
- Store unit in a clean, dry area. Do not store next to corrosive materials such as fertilizer.
- **NEVER** store the machine or fuel container inside where there is an open flame, spark or pilot light such as a water heater, furnace, clothes dryer, etc.

# SPECIFICATIONS

MODEL	BBT-MUL-6.5HPBS	BBT-MUL-7HPES	BBT-MUL-15HPES
Maximum RPM	3600 RPM	3600 RPM	3600 RPM
Horsepower	6.5 HP	7 HP	15 HP
Fuel Type	Unleaded 95 Octane or higher	Unleaded 95 Octane or higher	Unleaded 95 Octane or higher
Fuel Capacity	3.5L	3.5L	7L
Oil Type	SAE30	SAE30	SAE30
Oil Capacity	600ml	600ml	1100ml
Engine Type	Briggs & Stratton Vanguard	JD	JD
Displacement	196cc	208cc	420cc
Start Type	Pull Start	Electric Start & Pull Start	Electric Start & Pull Start
Chipper	YES	YES	YES
Mulcher	YES	YES	YES
Maximum Cutting Thickness Diameter	76mm	76mm	128mm x 80mm

Technical Data subject to change without notice.

# TROUBLESHOOTING

PROBLEM	CAUSE	REMEDY
Engine fails to start	<ol style="list-style-type: none"> <li>1. Spark plug lead disconnected.</li> <li>2. Fuel tank empty or stale fuel.</li> <li>3. Throttle control lever not in correct starting position.</li> <li>4. Choke not in CHOKE position.</li> <li>5. Fuel supply in OFF position.</li> <li>6. Blocked fuel line.</li> <li>7. Faulty spark plug.</li> <li>8. Low oil level.</li> </ol>	<ol style="list-style-type: none"> <li>1. Connect lead to spark plug.</li> <li>2. Fill tank with clean, fresh petrol.</li> <li>3. Move throttle lever to FAST position.</li> <li>4. Move choke to CHOKE position.</li> <li>5. Turn fuel to ON.</li> <li>6. Clean fuel line.</li> <li>7. Clean, adjust gap, or replace.</li> <li>8. Fill.</li> </ol>
Engine runs erratic	<ol style="list-style-type: none"> <li>1. Spark plug lead loose.</li> <li>2. Unit running on CHOKE.</li> <li>3. Blocked fuel line or stale fuel.</li> <li>4. Water or dirt in fuel system.</li> <li>5. Dirty air cleaner.</li> <li>6. Carburettor out of adjustment.</li> </ol>	<ol style="list-style-type: none"> <li>1. Connect and tighten spark plug lead.</li> <li>2. Move choke lever to OFF position.</li> <li>3. Clean fuel line; fill tank with clean, fresh fuel.</li> <li>4. Drain fuel tank. Refill with fresh fuel.</li> <li>5. Clean or replace air cleaner.</li> <li>6. See authorised service dealer.</li> </ol>
Too much vibration	<ol style="list-style-type: none"> <li>1. Loose parts or damaged impeller.</li> </ol>	<ol style="list-style-type: none"> <li>1. See authorised service dealer.</li> </ol>
Engine overheats	<ol style="list-style-type: none"> <li>1. Engine oil level low.</li> <li>2. Dirty air cleaner.</li> <li>3. Carburettor not adjusted properly.</li> </ol>	<ol style="list-style-type: none"> <li>1. Fill crankcase with oil.</li> <li>2. Clean or replace air cleaner.</li> <li>3. See authorised service dealer.</li> </ol>
Occasional skip (hesitates)	<ol style="list-style-type: none"> <li>1. Spark plug gap too close.</li> </ol>	<ol style="list-style-type: none"> <li>1. Adjust gap.</li> </ol>
Unit does not discharge	<ol style="list-style-type: none"> <li>1. Discharge chute clogged.</li> <li>2. Foreign object lodged in impeller.</li> <li>3. Low engine RPM.</li> </ol>	<ol style="list-style-type: none"> <li>1. Stop engine immediately and disconnect spark plug lead. Clean screen and inside of discharge opening.</li> <li>2. Stop engine and disconnect spark plug lead. Remove lodged object.</li> <li>3. Always run engine at full throttle.</li> </ol>
Rate of discharge slows	<ol style="list-style-type: none"> <li>1. Low engine RPM.</li> <li>2. Chipper blade dull.</li> </ol>	<ol style="list-style-type: none"> <li>1. Always run engine at full throttle.</li> <li>2. Replace chipper blade or see your authorised service dealer.</li> </ol>

# WARRANTY & SERVICE

## Warranties

Bigger Boyz Toyz offer a 1-year parts warranty on all products used for domestic use from the date of purchase. For all commercial use, a 3-month parts warranty period applies, unless specified in the item listing. All conditions below are based upon the product being faulty or not performing as described. In the instance where a return is required, the purchaser is liable for any shipping cost. Warranties will only be determined by a Bigger Boyz Toyz Technician upon inspection.

Warranties do not cover accidents, misuse, neglect, natural disaster or act of God or other external causes, or damage caused by operating the equipment in a manner that is not described in the instructions.

Our products come with guarantees that cannot be excluded under the Australian Consumer Law. You are entitled to a replacement or refund for a major failure and for compensation for any other reasonably foreseeable loss or damage. You are also entitled to have the goods repaired or replaced if the goods fail to be of acceptable quality and the failure does not amount to a major failure.

Parts purchases, consumable components and accessories such as chains, carry bags, batteries, hoses, grinding discs, covers, belts, cable, wheels and blades are not covered by standard warranty.

## Spare Parts

Spare parts are available. Please see our website ([www.bbta.com.au](http://www.bbta.com.au)) or contact us at [bbt@bbta.com.au](mailto:bbt@bbta.com.au) for more details.

# EXPLODED DIAGRAM & PARTS LIST

## Component Parts Diagram

NO	SKU	DESCRIPTION	QTY
1	SP-MUL-6.5HPBS-001	Rubber leg support	2
2	SP-MUL-6.5HPBS-002	Support leg	1
3	SP-MUL-6.5HPBS-003	Washer	
4	SP-MUL-6.5HPBS-004	Spring washer	
5	SP-MUL-6.5HPBS-005	Nut	
6	SP-MUL-6.5HPBS-006	Long bolt M8 205mm	3
7	SP-MUL-6.5HPBS-007	Discharge chute lower	1
8	SP-MUL-6.5HPBS-008	Discharge chute upper	1
9	SP-MUL-6.5HPBS-009	Tube12mm x 1.5Mm	4
10	SP-MUL-6.5HPBS-010	Screen	1
12	SP-MUL-6.5HPBS-012	Hatch pin	2
14	SP-MUL-6.5HPBS-014	Spacer 1	4
15	SP-MUL-6.5HPBS-015	Spacer 2	8
16	SP-MUL-6.5HPBS-016	Spacer 3	4
17	SP-MUL-6.5HPBS-017	Hammer blade	16
18	SP-MUL-6.5HPBS-018	Spacer 4	4
19	SP-MUL-6.5HPBS-019	Columnar pin	4
20	SP-MUL-6.5HPBS-020	Hammer axis	4
21	SP-MUL-6.5HPBS-021	Chipper blade	2
22	SP-MUL-6.5HPBS-022	Inner hex screw M8 x 25mm	6
23	SP-MUL-6.5HPBS-023	Left steel board	1
24	SP-MUL-6.5HPBS-024	Wheel	2
25	SP-MUL-6.5HPBS-025	Rear wheel support	2
26	SP-MUL-6.5HPBS-026	Inspection cover	1
27	SP-MUL-6.5HPBS-027	Steel wire ring 1	1
28	SP-MUL-6.5HPBS-028	Washer (right)	1
30	SP-MUL-6.5HPBS-030	Bearing seat	2
31	SP-MUL-6.5HPBS-031	Bearing	2
32	SP-MUL-6.5HPBS-032	Cushion (right)	1
33	SP-MUL-6.5HPBS-033	Blade tray	1
34	SP-MUL-6.5HPBS-034	Belt key	1
35	SP-MUL-6.5HPBS-035	Rear board	1
36	SP-MUL-6.5HPBS-036	Engine seat	1
37	SP-MUL-6.5HPBS-037	Tool box	1
38	SP-MUL-6.5HPBS-038	Rubber gasket	1
39	SP-MUL-6.5HPBS-039	Hopper	1
40	SP-MUL-6.5HPBS-040	Handle grip	2
41	SP-MUL-6.5HPBS-041	Hook	2
42	SP-MUL-6.5HPBS-042	Hex bolt	
44	SP-MUL-6.5HPBS-044	Clutch	1
45	SP-MUL-6.5HPBS-045	V-belt	
46	SP-MUL-6.5HPBS-046	Belt cover	
47	SP-MUL-6.5HPBS-047	Steel wire ring 2	1
48	SP-MUL-6.5HPBS-048	Steel washer	1
49	SP-MUL-6.5HPBS-049	Belt pulley	1
50	SP-MUL-6.5HPBS-050	Washer (left)	1
51	SP-MUL-6.5HPBS-051	Cushion (left)	1
52	SP-MUL-6.5HPBS-052	Right steel board	1
53	SP-MUL-6.5HPBS-053	Bolt	3
54	SP-MUL-6.5HPBS-054	Wheel axle	1

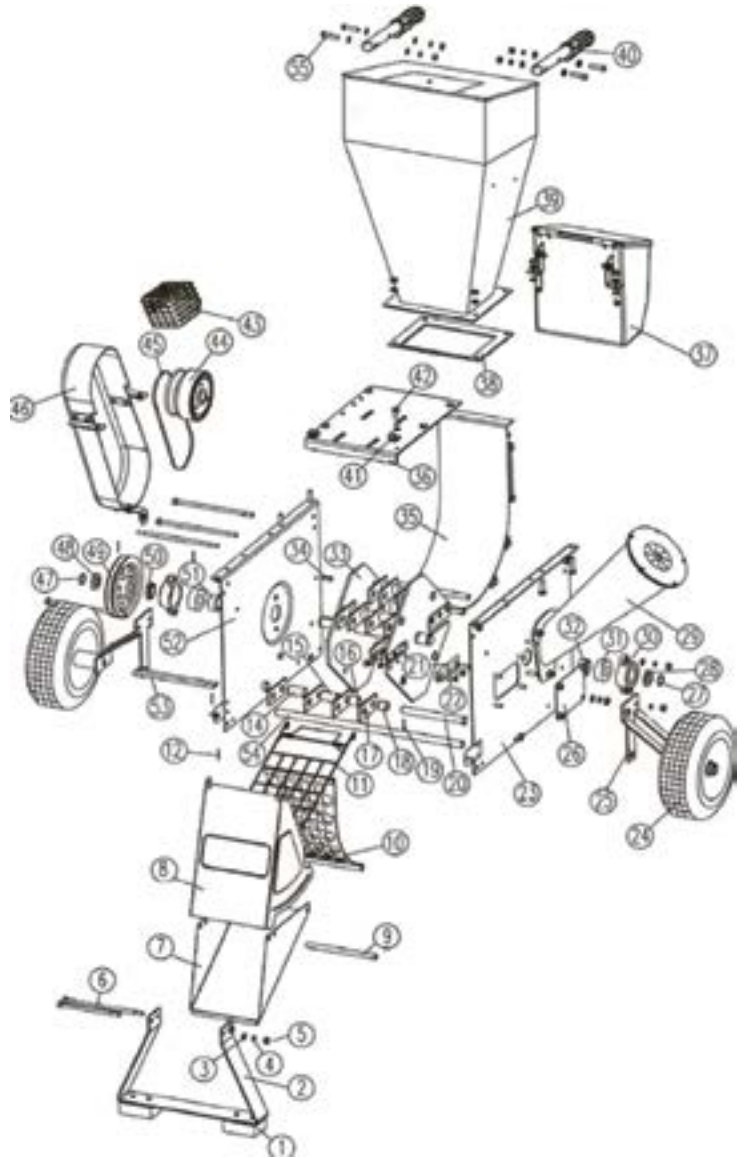

**NOTE:** Due to continuous product improvement, we reserve the right to change the product without prior notice



## YOU MAY ALSO LIKE



Chainsaws



Blowers



Lawn Mowers



Chainsaw Sharpeners

Enquiry or problems with our products?

**CALL US (02) 4257 4787**



**[www.bbta.com.au](http://www.bbta.com.au)**

COPYRIGHT © BIGGER BOYZ TOYZ AUSTRALIA PTY  
Unit 2/3 Delta Place Albion Park Rail NSW 2527  
BBT-MUL-Master-MNL1804